



Schraubtechnik

Automation

Druckluftmotoren

Druckluftwerkzeuge



DEPRAG

Einsteckwerkzeuge für Schrauber

Klingen
Führungshülsen
Steckschlüssel
Halter
Stiftschraubenfutter

Höchste Standzeit und Verschleißfestigkeit bei optimaler Passform - alle unsere Einsteckwerkzeuge sind abgestimmt auf den industriellen Einsatz mit Dreh- und Schlagschraubern. Die Vielfalt unseres Angebotes umfasst die Normalwerkzeuge, unsere standardisierten Sonderlösungen und - wenn auch diese nicht mehr ausreichen - bieten wir Ihnen individuelle

Konstruktionen. Um bei der nötigen Auswahl eine wirtschaftliche Lösung im Hinblick auf Standzeit, Handhabung und Preis zu erreichen, stehen wir Ihnen mit umfassender Beratung und Service zur Seite. Was immer Sie zu schrauben haben, Sie erhalten Ihr Werkzeug von uns. Fragen Sie uns.



Einsteckwerkzeuge im Internet

Diese Druckschrift zeigt Ihnen eine Auswahl von Einsteckwerkzeugen für unsere MICROMAT®-/MINIMAT®-Schrauber.

Ein weitaus größeres Angebot an Einsteckwerkzeugen finden Sie jetzt im Internet unter:

www.deprag.de → Schraubtechnik → Auswahlprogramm Einsteckwerkzeuge

Mit diesem Auswahlprogramm, das permanent aktualisiert wird, haben Sie die Möglichkeit, die passenden Einsteckwerkzeuge für Ihren DEPRAG-Schrauber zu finden.

Einfach per Mausklick die erforderlichen Parameter aus der vorgegebenen Liste auswählen und Sie erhalten eine Bestell-Nummer sowie die Lieferzeit.



Jetzt nur noch eine Anfrage per E-mail an verkauf@deprag.de schicken und Sie erhalten umgehend unser Preisangebot.

Beispiel:

Gesucht: Klinge für Phillips Kreuzschlitzschraube, Größe 2, Länge 103 mm

Die Angabe für den Antrieb ist abhängig vom verwendeten Schrauber.

[Klingen/Bits] [Klingenrohling] [Steckschlüssel] [Halter] [Tasthülse] [Führungshülse]

Abtrieb:	 Phillips	
Abtriebsgröße:	2	
Antrieb:	E6,3	
Klingenlänge:	103.0mm	

Wir haben für Sie:

Bestellnummer	324331
Type	PHI2x6,1x103
Bezeichnung	KLINGE E6,3

ab Lager lieferbar

© 2005 - DEPRAG Schulz GmbH u. CO., Amberg

Für MICROMAT®-Schrauber

Klingen, Führungshülsen (ohne und mit Schraubenansaugung)

Schlitzschrauben						Führungshülse 1)		Klinge		
DIN 84	DIN 963	DIN 964	DIN 7971	DIN 7972	DIN 7973	Kopf Ø mm	d mm	Bestell-Nr.	Schneide mm	Bestell-Nr.
—	M 1,6	—	—	—	—	3,0	4,0	325612	0,4 x 2,0	341689
M 1,6	—	M 1,6	—	—	—	3,0	4,0	341697	0,4 x 2,5	341690
M 2	M 2	M 2	—	—	—	3,8	4,8	323862	0,5 x 3,0	323854
—	—	—	2,2	—	—	4,2	5,3	341739	0,6 x 3,5	341691
—	—	—	—	2,2	2,2	4,3	5,5	341740	0,5 x 3,0	323854
M 2,5	—	—	—	—	—	4,5	5,6	341698	0,6 x 3,5	341691
—	M 2,5	M 2,5	—	—	—	4,7	5,8	341702	0,6 x 3,5	341691
M 3	M 3	M 3	2,9	2,9	2,9	5,6	6,6	323864	0,8 x 4,0	341692

1) hierzu Federhülse kpl. siehe Druckschrift des betreffenden Schraubers (Zubehör auf besondere Bestellung)

Klingen/Bits, geschlitzte Führungshülsen, Halter (ohne Magnet)

Schlitzschrauben						Führungshülse		Klinge/Bit		Halter (ohne Magnet)	
DIN 84	DIN 963	DIN 964	DIN 7971	DIN 7972	DIN 7973	Kopf Ø mm	d mm	Bestell-Nr.	Schneide mm	Bestell-Nr.	Bestell-Nr.
M 2	M 2	M 2	—	—	—	3,8	5,0	80 39 40	0,5 x 3	80 36 06	80 39 30
—	—	—	2,2	—	—	4,2	5,5	34 17 83	0,6 x 3,5	80 39 35	
—	—	—	—	2,2	2,2	4,3	5,5	34 17 84	0,5 x 3	80 36 06	
M 2,5	—	—	—	—	—	4,5	6,0	80 39 44	0,6 x 3,5	80 39 35	
—	M 2,5	M 2,5	—	—	—	4,7	6,0	80 39 44	0,6 x 3,5	80 39 35	
M 3	—	—	—	2,9	2,9	5,5	7,0	80 39 43	0,8 x 4	80 36 07	
—	M 3	M 3	2,9	—	—	5,6	7,0	80 39 43	0,8 x 4	80 36 07	

Klingen/Bits, Führungshülsen, Halter (mit Magnet)

Schlitzschrauben						Führungshülse		Klinge/Bit		Halter (mit Magnet)	
DIN 84	DIN 963	DIN 964	DIN 7971	DIN 7972	DIN 7973	Kopf Ø mm	d mm	Bestell-Nr.	Schneide mm	Bestell-Nr.	Bestell-Nr.
M 2	M 2	M 2	—	—	—	3,8	5,0	80 39 45	0,5 x 3	80 36 06	80 39 29
—	—	—	2,2	—	—	4,2	5,5	80 39 49	0,6 x 3,5	80 39 35	
—	—	—	—	2,2	2,2	4,3	5,5	80 39 49	0,6 x 3,5	80 39 35	
M 2,5	—	—	—	—	—	4,5	5,5	80 39 49	0,6 x 3,5	80 39 35	
—	M 2,5	M 2,5	—	—	—	4,7	6,0	80 39 46	0,6 x 3,5	80 39 35	
M 3	—	—	—	2,9	2,9	5,5	7,0	80 39 48	0,8 x 4	80 36 07	
—	M 3	M 3	2,9	—	—	5,6	7,0	80 39 48	0,8 x 4	80 36 07	

Klingen/Bits, Führungshülsen (ohne und mit Schraubenansaugung)

PHILLIPS-Kreuzschlitzschrauben POZIDRIV-Kreuzschlitzschrauben						ohne Ansaugung Klinge		mit Ansaugung					
DIN 965	DIN 966	DIN 7985	DIN 7981	DIN 7982	DIN 7983	Kopf Ø mm	Kreuz- schlitz- größe	PHILLIPS- Kreuzschlitz Bestell-Nr.	POZIDRIV- Kreuzschlitz Bestell-Nr.	d mm	Bestell-Nr.	PHILLIPS- Kreuzschlitz Bestell-Nr.	POZIDRIV- Kreuzschlitz Bestell-Nr.
M 1,6	M 1,6	—	—	—	—	3,0	0	32 39 06	80 36 13	3,8	32 38 61	32 39 06	35 35 71
—	—	M 1,6	—	—	—	3,2	0	32 39 06	80 36 13	4,2	32 97 19	32 39 06	35 35 71
M 2	M 2	—	—	—	—	3,8	1	32 39 07	32 39 08	4,8	32 38 62	32 57 41	33 02 01
—	—	M 2	—	—	—	4,0	1	32 39 07	32 39 08	5,2	32 62 30	32 57 41	33 02 01
—	—	—	2,2	—	—	4,2	1	32 39 07	32 39 08	5,2	32 45 71	32 39 07	32 39 08
—	—	—	—	2,2	2,2	4,3	1	32 39 07	32 39 08	5,2	32 45 71	32 39 07	32 39 08
M 2,5	M 2,5	—	—	—	—	4,7	1	32 39 07	32 39 08	5,7	32 43 41	32 39 07	32 39 08
—	—	M 2,5	—	—	—	5,0	1	32 39 07	32 39 08	6,6	32 62 31	32 39 07	32 39 08
—	—	—	—	2,9	2,9	5,5	1	32 39 07	32 39 08	6,6	32 38 64	32 39 07	32 39 08
M 3	M 3	—	2,9	—	—	5,6	1	32 39 07	32 39 08	6,6	32 38 64	32 39 07	32 39 08
—	—	M 3	—	—	—	6,0	1	32 39 07	32 39 08	7,0	32 46 59	32 39 07	32 39 08

1) hierzu Federhülse kpl. siehe Druckschrift des betreffenden Schraubers (Zubehör auf besondere Bestellung)

Klingen/Bits, Halter (ohne und mit Magnet)

PHILLIPS-Kreuzschlitzschrauben POZIDRIV-Kreuzschlitzschrauben						Klinge/Bit		Halter (ohne Magnet) oder Halter (mit Magnet)		
DIN 965	DIN 966	DIN 7985	DIN 7981	DIN 7982	DIN 7983	Kreuz- schlitz- Größe	PHILLIPS Bestell-Nr.	POZIDRIV Bestell-Nr.	Bestell-Nr.	Bestell-Nr.
M 1,6	M 1,6	M 1,6	—	—	—	0	803950	803924		
M 2	M 2	M 2	2,2	2,2	2,2	1	803951	803925	803930	803929
M 1,6	M 1,6	M 1,6	—	—	—	1	803951	803925		
M 2	M 2	M 2	—	—	—	1	803951	803925		
M 2,5	M 2,5	M 2,5	2,9	2,9	2,9	1	803951	803925		
M 3	M 3	M 3	—	—	—	2	803952	803612		

Klingen/Bits, Halter (ohne und mit Magnet)

Innensechskant- Innentorx- schrauben			Gewindestifte mit Innensechskant				Skt.-Klinge/Bit	Torx-Klinge/Bit	Halter (ohne Magnet) oder Halter (mit Magnet)			
DIN 912	DIN 7984	DIN 7991	DIN 913	DIN 914	DIN 915	DIN 916	SW mm	Bestell-Nr.	Torx- Größe	Bestell-Nr.	Bestell-Nr.	Bestell-Nr.
—	—	—	—	—	—	—	0,9	803955	—	—		
M 1,6	—	—	—	—	—	—	1,5	803956	—	—		
M 2	—	—	—	—	—	—	1,5	803956	T 6	803600		
—	—	—	—	—	—	—	—	—	T 7	803604		
M 2,5	—	—	—	—	—	—	2	803957	T 8	803601		
—	—	—	—	—	—	—	—	—	T 9	803603	803930	803929
—	M 3	M 3	—	—	—	—	2	803957	T 10	803602		
M 3	—	—	—	—	—	—	2,5	803958	T 10	803602		
—	—	—	—	—	—	—	3	803959	T 15	803608		

Für MICROMAT®-Schrauber

Klingen

Innentorxschrauben				Torx-Größe	Bestell-Nr.
DIN 912	DIN 7984	DIN 7991			
M 2	—	—	T 6	803926	
—	—	—	T 7	803586	
M 2,5	—	—	T 8	803587	
M 3	M 3	M 3	T 10	803589	

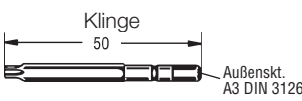

Steckschlüssel mit Schaft (ohne und mit Schraubenansaugung)



Sechskantschrauben					ohne Schraubenansaugung			mit Schraubenansaugung			
Sechskantmuttern					Steckschlüssel mit Schaft			Federhülse	Steckschlüssel mit Schaft		
DIN 931	DIN 933	DIN 439	DIN 934	Schlüsselweite mm	d mm	L mm	Bestell-Nr.	Bestell-Nr.	d mm	L mm	Bestell-Nr.
M 2	M 2	M 2	M 2	4	8	43	803960	330633	7	40	324587
M 2,5	M 2,5	M 2,5	M 2,5	5	9	43	803961	330634	8	40	324588
M 3	M 3	M 3	M 3	5,5	10	43	803962	330634	8	44	324589

Klingen und Führungshülsen halbfertig (nicht gehärtet)

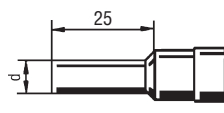

Sonderklingen

Führungshülse							Außensechskant A3 DIN 3126			Außensechskant A3 DIN 3126			Außensechskant A3 DIN 3126			
D mm	d ₁ mm	d ₂ mm	L mm	l mm	t mm	Best.-Nr.	d mm	L mm	Bestell-Nr.	Schneide mm	L mm	Best.-Nr.	Kreuzschlitzgröße	L mm	PHILLIPS-Best.-Nr.	POZIDRIV-Best.-Nr.
5,0	1,5	3,0	30,5	24	19,5	490013	3,6	102	490230	0,20 x 1,0	50	324098	1	75	328176	333917
5,5	1,5	3,9	30,5	24	19,5	490014	3,6	130	490229	0,25 x 1,5	50	324099	1	90	339921	339922
6,6	1,5	4,8	31,5	25	20,5	490015	4,0	100	490228	0,25 x 2,0	50	324100	1	102	327520	337990
6,6	—	4,8	84,5	78	20,5	490069	4,0	152	490212	0,40 x 4,0	90	339923	0	152	348426	—
										0,50 x 4,0	90	339924	1	152	348430	348431
										0,70 x 4,0	90	339925				

Für MINIMAT[®]-, Demontage-, Rutschkupplungsschrauber

Schlitzschrauben											Klingen, Führungshülsen					
											kurze Ausführung ohne Schraubenansaugung				lange Ausführung ohne Schraubenansaugung,	
																
																
DIN 84	DIN 85	DIN 963	DIN 964	DIN 7971	DIN 7972	DIN 7973	DIN 95	DIN 96	DIN 97	Kopf Ø mm	d mm	Führungshülse ²⁾ Bestell-Nr.	Schneide mm	Klinge Bestell-Nr.	d mm	Führungshülse ²⁾ Bestell-Nr.
M 2	—	M 2	M 2	—	—	—	—	—	2	3,8	5,5	322575	0,5 x 3	804001	6	325246
—	—	—	—	2,2	—	—	—	—	—	4	5,5	322575	0,5 x 3	804001	—	—
—	—	—	—	—	2,2	2,2	—	—	—	4,2	5,5	322575	0,5 x 3	804001	6	325247
—	—	—	—	—	—	—	—	—	—	4,3	6	342338	0,6 x 3,5	803598	6	325247
M 2,5	—	—	—	—	—	—	—	—	—	4,5	6	342338	0,6 x 3,5	803598	6	325248
—	—	M 2,5	M 2,5	—	—	—	—	—	—	4,7	7	342337	0,6 x 3,5	803598	6,5	325249
—	—	—	—	—	—	—	2,5	—	2,5	5	7	342346	0,6 x 4,5	803590	—	—
M 3	—	M 3	M 3	2,9	2,9	2,9	3	—	3	5,5/5,6	7	322573	0,8 x 4	803592	7	325133
—	M 3	—	—	—	—	—	—	—	3	6	7,5	342340	0,8 x 5,5	804012	7,5	325751
—	—	—	—	—	—	—	3,5	—	3,5	6,5	8,5	342344	0,8 x 4	803592	—	—
—	—	—	—	3,5	3,5	3,5	—	—	—	6,8/6,9	8,5	342339	1 x 5,5	803593	8,5	325250
—	—	—	—	—	—	—	—	—	—	7	8,5	342339	0,8 x 5,5	804012	—	—
M 4	—	—	—	—	—	—	—	—	—	7	8,5	342339	1 x 5,5	803593	8,5	325250
—	—	M 4	M 4	(3,9)	(3,9)	(3,9)	4	—	4	7,5	9,5	342342	1 x 5,5	803593	9	342258
—	M 4	—	—	4,2	4,2	4,2	—	—	—	8/8,1/8,2	9,5	342341	1,2 x 6,5	803872	9,5	342249
—	—	—	—	—	—	—	4,5	—	4,5	8,3	10,5	342345	1 x 5,5	803593	—	—
M 5	—	—	—	—	—	—	—	—	—	8,5	12	322630	1,2 x 8	804007	10	342248
—	—	—	—	—	—	—	—	—	4,5	9	10,5	342345	1 x 5,5	803593	—	—
—	—	M 5	M 5	—	—	—	5	—	5	9,2	12	322630	1,2 x 8	804007	11	325255
—	—	—	—	4,8	4,8	4,8	—	—	—	9,5	12	322630	1,2 x 8	804007	11	325256
—	M 5	—	—	—	—	—	—	—	—	10	12	322630	1,2 x 8	804007	12	325170
M 6	—	—	—	—	—	—	—	—	—	10	12	322630	1,6 x 8	803594	12	325170
—	—	M 6	M 6	—	—	—	6	—	6	11	13	342343	1,6 x 8	803594	13	342260

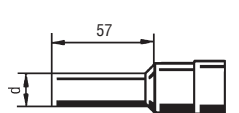
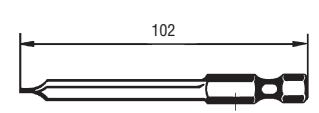
Für MINIMAT[®] -, Rutschkupplungsschrauber

Schlitzschrauben											Sonderklingen, Führungshülsen					
																
																
DIN 84	DIN 85	DIN 963	DIN 964	DIN 7971	DIN 7972	DIN 7973	DIN 95	DIN 96	DIN 97	Kopf Ø mm	d mm	Führungshülse ²⁾ Bestell-Nr.	Schneide mm	Klinge Bestell-Nr.	d mm	Führungshülse ²⁾ Bestell-Nr.
M 2	—	M 2	M 2	—	—	—	—	—	2	3,8	—	—	—	—	—	—
—	—	—	—	2,2	—	—	—	—	—	4	—	—	—	—	—	—
—	—	—	—	—	2,2	2,2	—	—	—	4,2	6	353891	0,7 x 3,5	804013	—	—
—	—	—	—	—	—	—	—	—	—	4,3	6	353891	0,7 x 3,5	804013	—	—
M 2,5	—	—	—	—	—	—	—	—	—	4,5	6	353892	0,7 x 3,5	804013	—	—
—	—	M 2,5	M 2,5	—	—	—	—	—	—	4,7	6,5	353894	0,7 x 3,5	804013	—	—
—	—	—	—	—	—	—	2,5	—	2,5	5	—	—	—	—	—	—
M 3	—	M 3	M 3	2,9	2,9	2,9	3	—	3	5,5/5,6	7	353897	0,8 x 4	804014	—	—
—	M 3	—	—	—	—	—	—	—	3	6	7,5	333680	0,8 x 4,7	804018	—	—
—	—	—	—	—	—	—	3,5	—	3,5	6,5	—	—	—	—	—	—
—	—	—	—	3,5	3,5	3,5	—	—	—	6,8/6,9	8,5	332770	0,9 x 5,5	804015	—	—
—	—	—	—	—	—	—	—	—	—	7	—	—	—	—	—	—
M 4	—	—	—	—	—	—	—	—	—	7	8,5	332770	0,9 x 5,5	804015	—	—
—	—	M 4	M 4	(3,9)	(3,9)	(3,9)	4	—	4	7,5	9	346365	1 x 6,3	804019	—	—
—	M 4	—	—	4,2	4,2	4,2	—	—	—	8/8,1/8,2	9,5	333681	1 x 7	804016	—	—
—	—	—	—	—	—	—	4,5	—	4,5	8,3	—	—	—	—	—	—
M 5	—	—	—	—	—	—	—	—	—	8,5	10	351811	1 x 7	804016	—	—
—	—	—	—	—	—	—	—	—	—	9	—	—	—	—	—	—
—	—	M 5	M 5	—	—	—	5	—	5	9,2	11	331735	1,2 x 8	804017	—	—
—	—	—	—	4,8	4,8	4,8	—	—	—	9,5	11,5	351813	1,2 x 8	804017	—	—
—	M 5	—	—	—	—	—	—	—	—	10	12	326388	1,2 x 8	804017	—	—
M 6	—	—	—	—	—	—	—	—	—	10	12	326388	1,2 x 8	804017	—	—
—	—	M 6	M 6	—	—	—	6	—	6	11	13	326389	1,2 x 8	804017	—	—

¹⁾ Schraubenansaugung für Holzschrauben nicht empfehlenswert

²⁾ hierzu Federhülse kpl. siehe Druckschrift des betreffenden Schraubers (Zubehör auf besondere Bestellung)

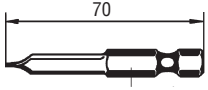
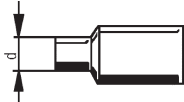
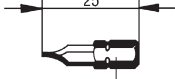
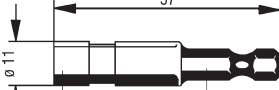
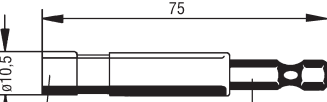

Für MINIMAT[®]-, Demontage-, Rutschkupplungs-, Impuls-, Elektroschrauber

Klingen/Bits, Führungshülsen, Halter (ohne und mit Magnet)

 Außensechskant E6,3 DIN 3126 (1/4")				 Außensechskant C6,3 DIN 3126 (1/4")		 Innensechskant D6,3 DIN 3126 (1/4")		 Innensechskant D6,3 DIN 3126 (1/4")	
Schneide mm	Klinge Bestell-Nr.	d mm	Führungshülse Bestell-Nr.	Schneide mm	Klinge/Bit Bestell-Nr.	ohne Magnet Bestell-Nr.	mit Magnet Bestell-Nr.		
0,5 x 3	804021	6	354698	0,5 x 3	820883				
—	—	6	354698	0,5 x 3	820883				
0,5 x 3	804021	6,5	354699	0,6 x 3,5	821071/3				
0,5 x 3	804021	6,5	354699	0,6 x 3,5	821071/3				
0,5 x 3	804021	7	354700	0,6 x 3,5	821071/3				
0,5 x 3	804021	7	354700	0,6 x 3,5	821071/3				
—	—	7,5	341388	0,6 x 4,5	803841				
0,8 x 4	803595	8	354701	0,8 x 5	803842				
0,8 x 4	803595	8	334920	0,8 x 5,5	803969				
—	—	8,5	354702	0,8 x 5,5	803969				
1 x 5,5	803596	9	354468	0,8 x 5,5	803969				
—	—	9	354468	0,8 x 5,5	803969				
1 x 5,5	803596	9	354703	1,2 x 6,5	821072/3	804602	821068		
1 x 5,5	803596	10	354704	1 x 5,5	821075				
1,2 x 6,5	803873	10,5	354705	1,2 x 6,5	821072/3				
—	—	10,5	354706	1 x 5,5	821075				
1,2 x 6,5	803873	10,5	354707	1,2 x 8	803846				
—	—	11	354708	1 x 5,5	821075				
1,2 x 8	804027	11,5	354709	1,2 x 6,5	821072/3				
1,2 x 8	804027	11,5	354710	1,2 x 8	803846				
1,2 x 8	804027	12,5	354711	1,2 x 8	803846				
1,6 x 8	803597	12,5	354711	1,6 x 8	821076				
1,6 x 8	803597	13,5	354712	1,6 x 8	821076				

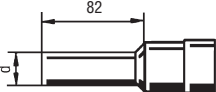
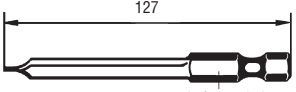
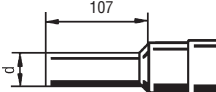
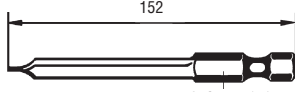
ohne Schraubenansaugung
mit Schraubenansaugung (nur für MINIMAT[®] gerade Schrauber Gr. 1 und 2)

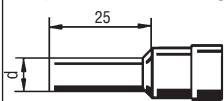
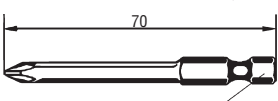
		 Außensechskant E6,3 DIN 3126 (1/4")				 Außensechskant E6,3 DIN 3126 (1/4")	
d mm	Führungshülse ²⁾ Bestell-Nr.	Schneide mm	Klinge Bestell-Nr.	d mm	Führungshülse ²⁾ Bestell-Nr.	Schneide mm	Klinge Bestell-Nr.
—	—	—	—	—	—	—	—
—	—	—	—	—	—	—	—
—	—	—	—	—	—	—	—
—	—	—	—	—	—	—	—
—	—	—	—	—	—	—	—
—	—	—	—	—	—	—	—
7	353904	0,8 x 4	804034	7	343915	0,8 x 4	803979
7,5	330731	0,8 x 4,7	804039	7,5	328972	0,8 x 4,7	803980
—	—	—	—	—	—	—	—
8,5	353905	0,9 x 5,5	804035	8,5	353911	0,9 x 5,5	803981
—	—	—	—	—	—	—	—
8,5	353905	0,9 x 5,5	804035	8,5	353911	0,9 x 5,5	803981
9	330178	1 x 6,3	804033	9	353912	1 x 6,3	803982
9,5	353906	1 x 7	804036	9,5	353913	1 x 7	803983
—	—	—	—	—	—	—	—
10	326669	1 x 7	804036	10	332775	1 x 7	803983
—	—	—	—	—	—	—	—
11	353907	1,2 x 8	804037/1	11	353914	1,2 x 8	803984
11,5	353909	1,2 x 8	804037/1	11,5	353915	1,2 x 8	803984
12	325518	1,2 x 8	804037/1	12	337006	1,2 x 8	803984
12	325518	1,2 x 8	804037/1	12	337006	1,2 x 8	803984
13	353910	1,2 x 8	804037/1	13	353916	1,2 x 8	803984

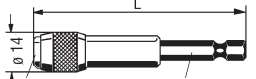
Für MINIMAT®-Schrauber				Für MINIMAT®-, Demontage-, Rutschkupplungs-, Impuls-, Elektroschrauber							
Klingen, Führungshülsen lange Ausführung, mit Schraubenansaugung (nur für MINIMAT® gerade Schrauber Gr. 1 u. 2)				Klingen/Bits, Halter (ohne und mit Magnet)							
											
d mm	Führungshülse 2) Bestell-Nr.	PHILLIPS Kreuzschlitz Bestell-Nr.	POZIDRIV Kreuzschlitz Bestell-Nr.	PHILLIPS Kreuzschlitz Bestell-Nr.	POZIDRIV Kreuzschlitz Bestell-Nr.	L mm	ohne Magnet Bestell-Nr.	L mm	mit Magnet Bestell-Nr.	L mm	mit Magnet und Schnellwechselfutter Bestell-Nr.
6	325246	804045	—	804635	804641/3						
6	325246	338894	339140	804636	804665						
5	330742	338894	339140	804636	804665						
6	325247	338894	339140	804636	804665						
6,5	325249	338894	339140	804636	804665						
6,5	329280	804046	803988	804636	804665						
7	325220	804046	803988	804636	804665						
7,5	325181	804046	803988	804636	804665						
—	—	—	—	804637	804666						
8,5	325251	804047	803989	804637	804666	57	804602	75	821068		
—	—	—	—	804637	804666	102	804639/1	150	330744	51,5	821692
9	325260	804047	803989	804637	804666	152	804614/1	204	335481	76,5	820150
9,5	325253	804047	803989	804637	804666	203	812944/1	250	334086	151,5	358131
—	—	—	—	804637	804666			300	330745		
—	—	—	—	804637	804666						
11	325255	804047	803989	804637	804666						
11	325256	804047	803989	804637	804666						
12	325170	804047	803989	804637	804666						
13	342260	804048	803990	804638	804667						
—	—	—	—	804638	804667						
—	—	—	—	804638	804667						
—	—	—	—	804640	804674						
—	—	—	—	804640	804674						

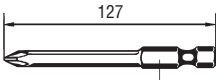
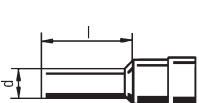
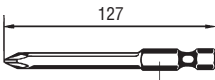
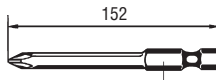
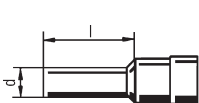
ohne Schraubenansaugung		mit Schraubenansaugung (nur für MINIMAT® gerade Schrauber Gr. 1 u. 2)					ohne Schraubenansaugung		mit Schraubenansaugung (nur für MINIMAT® gerade Schrauber Gr. 1 u. 2)						
															
Außensechskant E 6,3 DIN 3126 (1/4")		Außensechskant E 6,3 DIN 3126 (1/4")					Außensechskant E 6,3 DIN 3126 (1/4")		Außensechskant E 6,3 DIN 3126 (1/4")						
PHILLIPS Kreuzschlitz Bestell-Nr.	POZIDRIV Kreuzschlitz Bestell-Nr.	d mm	l mm	Führungs- hülse 2) Bestell-Nr.	PHILLIPS Kreuzschlitz Bestell-Nr.	POZIDRIV Kreuzschlitz Bestell-Nr.	PHILLIPS Kreuzschlitz Bestell-Nr.	POZIDRIV Kreuzschlitz Bestell-Nr.	d mm	l mm	Führungs- hülse 2) Bestell-Nr.	PHILLIPS Kreuzschlitz Bestell-Nr.	POZIDRIV Kreuzschlitz Bestell-Nr.		
325567	330255	7	82	353945	353944	339867	327986	327386	7	107	353955	346327	340727		
325567	330255	7	82	353946	353944	339867	327986	327386	7	107	353958	346327	340727		
325567	330255	7	82	353947	353944	339867	327986	327386	7	107	353959	346327	—		
325567	330255	7	82	353948	353944	339867	327986	327386	7	107	353960	346327	—		
325567	330255	7	82	353949	353944	339867	327986	327386	7	107	353961	346327	340727		
325567	330255	7,5	82	337383	325567	330255	327986	327386	7,5	107	337182	327986	327386		
325567	330255	7,5	82	330731	325567	330255	327986	327386	7,5	107	328972	327986	—		
331002	331003	—	—	—	—	—	328551	330026	—	—	—	—	—		
331002	331003	9,5	82	333555	331002	331003	328551	330026	9	107	332621	328551	330026		
331002	331003	—	—	—	—	—	328551	330026	—	—	—	—	—		
331002	331003	9	82	330178	331002	331003	328551	330026	9	107	353912	328551	—		
331002	331003	9,5	82	353950	331002	331003	328551	330026	9,5	107	353962	328551	—		
331002	331003	—	—	—	—	—	328551	330026	—	—	—	—	—		
331002	331003	—	—	—	—	—	328551	330026	—	—	—	—	—		
331002	331003	11	82	353952	331002	331003	328551	330026	11	107	353963	328551	—		
331002	331003	11,5	82	353953	331002	331003	328551	330026	11,5	107	353964	328551	—		
331002	331003	11,5	82	339264	331002	331003	328551	330026	12	107	326088	328551	330026		

Für MINIMAT[®]-, Demontage-, Rutschkupplungs-, Elektroschrauber

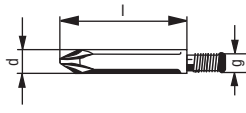
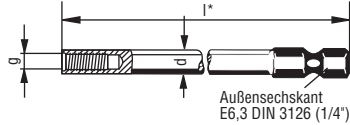
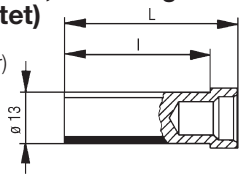
Schraubbits						Schraubbithalter				Führungshülsen, halbfertig (nicht gehärtet) (nicht für Elektroschrauber)			
													
Kreuzschlitzgröße	d mm	g	l mm	PHILLIPS Kreuzschlitz Bestell-Nr.	POZIDRIV Kreuzschlitz Bestell-Nr.	d mm	g	l mm	Bestell-Nr.	L mm	l mm	Klingenlänge mm	Bestell-Nr.
1	5,56	8-32	22	803744/1	803707/1	5,6	8-32	80	337500	23	15	50	490199
1	6,35	10-32	34	803747/1	803748/1	5,6	8-32	105	337499	44	37	70	490031
1	5	M 4	25	803728/1	—	5,6	8-32	130	334316	64	57	89	490105
1	5,5	M 4	25	—	803750/3	5,6	8-32	156	353697	101	94	102/127	490107
2	5,56	8-32	22	803745/1	803729/1	5,6	8-32	168	334420	126	119	152	490108
2	6,35	10-32	34	803746/1	803749/1	5,6	8-32	178	353694				
2	6	M 5	34	803855	803856	6,35	10-32	68	337497				
						6,35	10-32	93	336707				
						6,35	10-32	118	334315				
						6,35	10-32	144	341042				
						6,35	10-32	156	334421				
						6,35	10-32	166	355758				
						5,5	M 4	77	337520				
						5,5	M 4	102	337521				
						5,5	M 4	127	335637				
						5,5	M 4	153	354233				
						5,5	M 4	165	341765				
						5,5	M 4	175	347107				
						7	M 5	68	348745				
						7	M 5	77	344689				
						7	M 5	92	349569				
						7	M 5	102	344819				
						7	M 5	117	345466				
						7	M 5	127	343309				
						7	M 5	143	357736				
						7	M 5	155	346886				
						7	M 5	165	348235				
						7	M 5	170	348417				
						8	M 6	77	362258				
						8	M 6	102	370770				
						8	M 6	127	371868				
						8	M 6	155	351713				
						8	M 6	185	351533				

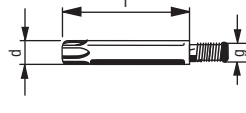
Schraubbits				
				
Torx-Größe	d mm	g	l mm	Torx Bestell-Nr.
T 8	5,5	M 4	25	820235/3
T 10	6	10-32	34	822235/3
T 10	5,5	M 4	25	803753
T 10	6	M 5	34	823894/3
T 15	6	10-32	34	812945/3
T 15	5,5	M 4	25	803754
T 15	6	M 5	34	820603/3
T 20	6	10-32	34	820297/3
T 20	5,5	M 4	25	803756/3
T 20	6	M 5	34	812894/3
T 20	7	M 5	25	821042/3
T 25	6	10-32	34	820298/3
T 25	5,5	M 4	25	825008/3
T 25	6	M 5	34	822106/3
T 25	7	M 6	25	821760/3
T 30	6	10-32	34	820299/3
T 30	7	M 5	25	803706/3
T 30	7	M 6	25	821061/3
T 40	7	M 5	25	821932/3

*) Sonderlängen auf Anfrage

Klingen, halbfertig (nicht gehärtet)

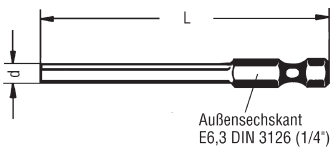

Halter

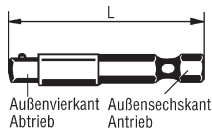

Stiftschraubenfutter



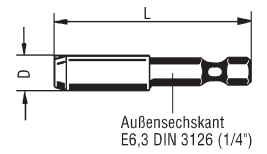

● Stiftschrauben

DIN 835
DIN 938
DIN 939



d mm	L mm	Bestell-Nr.	Antrieb DIN 3126	Abtrieb DIN 3121	L mm	Bestell-Nr.		D mm	L mm	Bestell-Nr.
7	70	490221	E 6,3 (1/4")	E 6,3 (1/4")	50	804050	M 3	9	50	390287
7	102	490222	E 6,3 (1/4")	E 6,3 (1/4")	76	803647/1	M 4	9	50	390285
7	127	490223	E 6,3 (1/4")	E 6,3 (1/4")	100	804051	M 5	9	50	390335
7	152	490224	E 6,3 (1/4")	E 6,3 (1/4")	152	803808/1	M 6	9	50	390288
7	200	490225	E 6,3 (1/4")	E 6,3 (1/4")	203	803809/1	M 8	16	55	390295
7	260	490279	E 6,3 (1/4")	E 6,3 (1/4")	254	803810/1	M 10	16	55	390339
7	300	490281	E 6,3 (1/4")	E 6,3 (1/4")	305	803811/1	M 12	16	55	390338
8	300	490319	E 6,3 (1/4")	E 6,3 (1/4")	355	803798/1				
			E 6,3 (1/4")	E 6,3 (1/4")	406	820766/1				
			E 6,3 (1/4")	E 10 (3/8")	50	804052/1				
			E 6,3 (1/4")	E 10 (3/8")	76	820145/1				
			E 6,3 (1/4")	E 10 (3/8")	100	803807				
			E 6,3 (1/4")	E 10 (3/8")	152	820392/1				
			E 6,3 (1/4")	E 10 (3/8")	254	803805/1				
			E 6,3 (1/4")	E 12,5 (1/2")	50	804053				
			E 6,3 (1/4")	E 12,5 (1/2")	152	820035/1				

Für MINIMAT[®]-, Demontage-, Rutschkupplungs-, Impuls-, Elektroschrauber

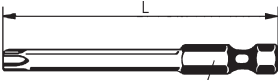
 Innensechskant-  Gewindestifte mit Innensechskant				 Innentorxschrauben		 Außensechskant E6,3 DIN 3126 (1/4") Sechskant-Klinge		Klingen  Außensechskant E6,3 DIN 3126 (1/4") Torx-Klinge						
DIN 912	DIN 7984	DIN 7991	DIN 913	DIN 914	DIN 915	DIN 916	Schlüsselweite mm	L = 50 mm Bestell-Nr.	L = 70 mm Bestell-Nr.	Torx-Größe	L = 50 mm Bestell-Nr.	L = 70 mm Bestell-Nr.	L = 89 mm Bestell-Nr.	L = 152 mm Bestell-Nr.
M 1,6	—	—	—	—	—	—	—	—	—	—	—	—	—	—
M 2	—	—	—	M 3	—	—	—	—	—	T 6	821092	821516	821055/1	823038
—	—	—	—	—	—	—	—	—	—	T 7	803535/1	803548/1	803560/1	823520/1
M 2,5	—	—	—	—	—	—	2	324814/3	327153	T 8	803536	803866/3	803561	803575
—	—	—	—	—	—	—	—	—	—	T 9	803537/1	803549/1	803562/1	803576/1
—	M 3	M 3	—	M 4	—	—	2	324814/3	327153	T 10	803869/1	803550	803563/1	803868
M 3	—	—	—	—	—	—	2,5	804114	325565	T 10	803869/1	803550	803563/1	803868
—	—	—	—	—	—	—	—	—	—	T 15	803538/1	812914	803564/1	803577/1
—	M 4	M 4	—	M 5	—	—	2,5	804114	325565	T 20	803539/1	812915	803565/1	803578/1
M 4	—	—	—	—	—	—	3	804115	803975	T 20	803539/1	812915	803565/1	803578/1
—	M 5	M 5	—	M 6	—	—	3	804115	803975	T 25	803540/1	812916	803566/1	803579/1
M 5	—	—	—	—	—	—	4	804116	803976	T 25	803540/1	812916	803566/1	803579/1
—	—	—	—	—	—	—	—	—	—	T 27	803541/1	812917	822995/1	803580/1
—	M 6	M 6	—	M 8	—	—	4	804116	803976	T 30	803542/1	812918	803568/1	803581/1
M 6	—	—	—	M 10	—	—	5	804117	803977	T 30	803542/1	812918	803568/1	803581/1
—	M 8	M 8	—	—	—	—	5	804117	803977	T 40	803543/1	803556	803569/1	803582/1
M 8	—	—	—	M 12	—	—	6	804118	803978	T 40	803543/1	803556	803569/1	803582/1
M 10	M 12	M 12	—	M 16	—	—	8	803678	812928/3	—	—	—	—	—

Klingen/Bits, Halter (ohne und mit Magnet)

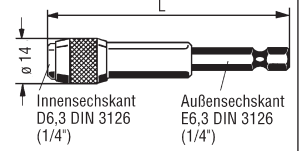
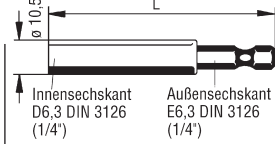
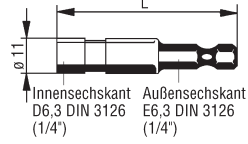
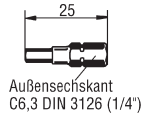

Schlüssel- weite mm	Sechskant- Klinge/Bit Bestell-Nr.	Torx- Größe	Torx-Klinge/Bit Bestell-Nr.	ohne Magnet		mit Magnet		mit Magnet und Schnellwechselfutter	
				L mm	Bestell-Nr.	L mm	Bestell-Nr.	L mm	Bestell-Nr.
1,5	820302	—	—						
1,5	820302	T 6	803520						
—	—	T 7	803521						
2	804668	T 8	803522						
—	—	T 9	803523						
2	804668	T 10	803524	57	804602	75	821068	51,5	821692
2,5	804669	T 10	803524	102	804639/1	100	337722	76,5	820150
—	—	T 15	803525	152	804614/1	150	330744	151,5	358131
2,5	804669	T 20	803526	203	812944/1	204	335481		
3	804670	T 20	803526			250	334086		
3	804670	T 25	803527			300	330745		
4	804671	T 25	803527						
—	—	T 27	803528						
4	804671	T 30	803529						
5	804672	T 30	803529						
5	804672	T 40	803530						
6	804673	T 40	803530						
8	803690	—	—						

Für SENSOMAT[®]-, Tiefenschrauber

Schlitzschrauben

DIN 84	DIN 85	DIN 963	DIN 964	DIN 7971	DIN 7972	DIN 7973	DIN 95	DIN 96	DIN 97	Kopf Ø mm
M 2	—	M 2	M 2	—	—	—	—	—	2	3,8
—	—	—	—	—	—	—	—	2	—	4
M 2,5	—	—	—	2,2	2,2	2,2	—	—	—	4,2/4,3
—	—	M 2,5	M 2,5	—	—	—	—	—	—	4,5
—	—	—	—	—	—	—	2,5	—	2,5	4,7
M 3	—	M 3	M 3	2,9	2,9	2,9	—	—	—	5,5/5,6
—	M 3	—	—	—	—	—	—	3	3	6
—	—	—	—	—	—	—	3,5	—	3,5	6,5
—	—	—	—	3,5	3,5	3,5	—	—	—	6,8/6,9
M 4	—	—	—	—	—	—	—	3,5	—	7
—	—	—	—	—	—	—	—	—	—	7
—	M 4	M 4	M 4	(3,9)	(3,9)	(3,9)	4	—	4	7,5
—	—	—	—	—	—	—	—	4	—	8
—	—	—	—	4,2	4,2	4,2	—	—	—	8,1/8,2
M 5	—	—	—	—	—	—	4,5	—	4,5	8,3
—	—	—	—	—	—	—	—	—	—	8,5
—	—	—	—	—	—	—	—	4,5	—	9

1) Nur als
Gewindefurchende-Schraube DIN 7500 (Kopfform und Abmaß nach DIN: 84, 85, 963 und 964)
Gewindeschneid-Schraube DIN 7513 (Kopfform und Abmaß nach DIN: 84, 963 und 964)

PHILLIPS-Kreuzschlitzschrauben

POZIDRIV-Kreuzschlitzschrauben

DIN 965	DIN 966	DIN 7985	DIN 7981	DIN 7982	DIN 7983	DIN 7995	DIN 7996	DIN 7997	Kreuzschlitz-Größe	Kopf Ø mm	d mm	l mm	Tasthülse Bestell-Nr.	PHILLIPS Bestell-Nr.	POZIDRIV Bestell-Nr.
M2	M2	—	—	—	—	—	—	—	1	3,8	6	17	346070	338894	339140
—	—	M2	—	—	—	—	—	—	1	4	6	17	346071	338894	339140
—	—	—	2,2	2,2	2,2	—	—	—	1	4,2/4,3	6	17	346072	338894	339140
M 2,5	M 2,5	—	—	—	—	2,5	—	2,5	1	4,7	6,5	17	346088	804046	803988
—	—	M 2,5	—	—	—	—	2,5	—	1	5	7	17	346089	804046	803988
M 3	M 3	—	2,9	2,9	2,9	3	—	3	1	5,5/5,6	7,5	17	346090	804046	803988
—	—	M 3	—	—	—	—	3	—	1	6	8	17	346091	804046	803988
—	—	—	—	—	—	3,5	—	3,5	2	6,5	8,5	17	346092	804047	803989
—	—	—	3,5	3,5	3,5	—	—	—	2	6,8/6,9	9	17	346093	804047	803989
—	—	—	—	—	—	—	3,5	—	2	7	9	17	346094	804047	803989
M 4	M 4	—	(3,9)	(3,9)	(3,9)	4	—	4	2	7,5	9	17	346095	804047	803989
—	—	M 4	—	—	—	—	4	—	2	8	10	20	346096	804047	803989
—	—	—	4,2	4,2	4,2	—	—	—	2	8,1/8,2	10	20	346084	804047	803989
—	—	—	—	—	—	4,5	—	4,5	2	8,3	10	20	346097	804047	803989
—	—	—	—	—	—	—	4,5	—	2	9	11	12	346098	804047	803989
M 5	M 5	—	—	—	—	5	—	5	2	9,2	11	12	346099	804047	803989
—	—	—	4,8	4,8	4,8	—	—	—	2	9,5	11,5	12	346100	804047	803989

1) Nur als
Gewindefurchende-Schraube DIN 7500 (Kopfform und Abmaß nach DIN: 965, 966 und 7985)
Gewindeschneid-Schraube DIN 7516 (Kopfform und Abmaß nach DIN: 965, 966 und 7985)

2) Außerdem Ausführung als Bohr-Schraube
DIN 7504 (Kopfform und Abmaß nach DIN: 7981, 7982 und 7983)

Tasthülsen, Klingen

hierzu Kontermutter, Führungshülse (und Federhülse), ohne und mit Schraubenansaugung *)

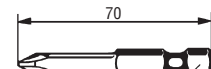
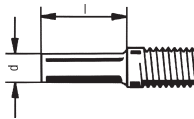

Außensechskant E6,3 DIN 3126 (1/4")

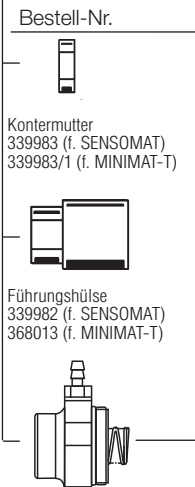

Federhülse 401613 A (MG1)
Federhülse 401613 B (MG2)
(nur bei Schrauben-ansaugung SENSOMAT)

*) Schraubenansaugung für Schneid- und Bohrschrauben (spanabhebend) nicht empfehlenswert

Tasthülsen, Klingen

hierzu Kontermutter mit Führungshülse,
ohne Schraubenansaugung

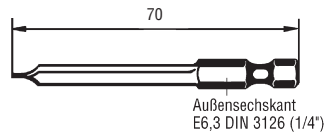
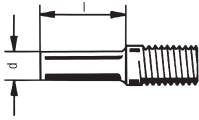

d mm	l mm	Tasthülse Bestell-Nr.	Schneide mm	Klinge Bestell-Nr.	Kontermutter Bestell-Nr.	Führungshülse Bestell-Nr.
6	17	346070	0,5 x 3	804021	339983 (f. SENSOMAT)	339982 (f. SENSOMAT)
6	17	346071	0,5 x 3	804021		
6	17	346072	0,5 x 3	804021		
6,5	17	346073	0,5 x 3	804021		
6,5	17	346074	0,5 x 3	804021		
7	17	346075	0,5 x 3	804021		
7,5	17	346076	0,8 x 4	803595		
8	17	346077	0,8 x 4	803595		
8,5	17	346078	0,8 x 4	803595		
9	17	346079	1,0 x 5,5	803596		
9	17	346080	0,8 x 4,0	803595		
9	17	346081	1,0 x 5,5	803596		
9	17	346082	1,0 x 5,5	803596		
10	20	346083	1,0 x 5,5	803596		
10	20	346084	1,2 x 6,5	803873		
10	20	346085	1,0 x 5,5	803596		
10	20	346086	1,2 x 6,5	803873		
11	12	346087	1,0 x 5,5	803596		
					339983/1 (f. MINIMAT-T)	368013 (f. MINIMAT-T)

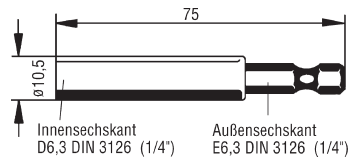
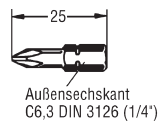
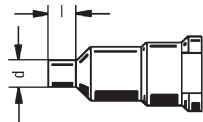

Tasthülsen, Klingen/Bits, Halter (mit Magnet)

hierzu Kontermutter mit Führungshülse,
ohne Schraubenansaugung







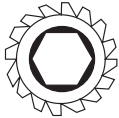
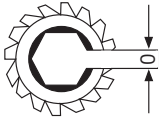

d mm	l mm	Tasthülse Bestell-Nr.	Klinge/Bit		Halter (mit Magnet) Bestell-Nr.	Kontermutter Bestell-Nr.	Führungshülse Bestell-Nr.
			PHILLIPS Bestell-Nr.	POZIDRIV Bestell-Nr.			
7	7	344123	804636	804665	821068	343982 (f. SENSOMAT)	343981 (f. SENSOMAT)
7	7	344123	804636	804665			
7	7	344123	804636	804665			
7	7	344123	804636	804665			
7	7	344123	804636	804665			
8	8	344124	804636	804665			
8	8	344124	804636	804665			
10	8	343983	804637	804666			
10	8	343983	804637	804666			
10	8	343983	804637	804666			
11,5	8	344125	804637	804666			
11,5	8	344125	804637	804666			
11,5	8	344125	804637	804666			
11,5	8	344125	804637	804666			
12,5	8	344126	804637	804666			
12,5	8	344126	804637	804666			
12,5	8	344126	804637	804666			
						343982 (f. MINIMAT-T)	369430 (f. MINIMAT-T)



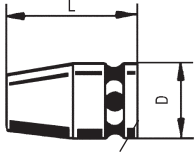
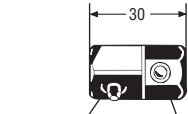

Für Flachkopfschrauber

 Sechskantschrauben  Sechskantmutter 					Schlüsseleinsätze mit Innensechskant					offener Kopf	
					geschlossener Kopf					39-331-43 O	
					39-521-19 K 39-331-19 K 39-331-21 K 39-331-32 K 39-331-32 L 39-331-46 K					Schlüsselöffnung ○ mm	
											
DIN 931	DIN 933	DIN 439	DIN 934	SW mm	Bestell-Nr.	Bestell-Nr.	Bestell-Nr.	Bestell-Nr.	Bestell-Nr.	mm	Bestell-Nr.
M 2,5	M 2,5	M 2,5	M 2,5	5	401467/8	—	—	—	—	—	—
M 3	M 3	M 3	M 3	5,5	401467/7	—	—	—	—	—	—
M 4	M 4	M 4	M 4	7	401467/5	804136	804185	—	—	—	—
M 5	M 5	M 5	M 5	8	401467/4	804137	804186	—	—	5,5	804171
M 6	M 6	M 6	M 6	10	401467/2	804138	804187	804139	—	8,5	804173
(M 7)	(M 7)	(M 7)	(M 7)	11	—	—	804188	804140	—	9,5	804174
—	—	—	—	12	—	—	—	804141	—	9,5	804175
M 8	M 8	M 8	M 8	13	—	—	—	804142	804154	11	804176
—	—	—	—	14	—	—	—	804143	804155	11	804177
—	—	—	—	15	—	—	—	804144	—	11	804178
M 10	M 10	M 10	M 10	16	—	—	—	821541	—	12	821993
(M 10)	(M 10)	(M 10)	(M 10)	17	—	—	—	804145	804157	12	804179
M 12	M 12	M 12	M 12	18	—	—	—	821542	—	—	—
(M 12)	(M 12)	(M 12)	(M 12)	19	—	—	—	804146	804158	—	—
M 14	M 14	M 14	M 14	22	—	—	—	—	804159	—	—
M 16	M 16	M 16	M 16	24	—	—	—	—	804160	—	—
M 18	M 18	M 18	M 18	27	—	—	—	—	804161	—	—
—	—	—	—	1/2"	—	—	—	804147	804165	—	—
—	—	—	—	5/8"	—	—	—	804148	—	12	804183

Zwischengrößen mit Innensechskant u. Schlüsseleinsätze mit Innenvierkant auf Anfrage

 Sechskantschrauben  Sechskantmutter 					Steckschlüssel, Halter					
					geschlossener Kopf					
					39-331-32 K 39-331-46 K		39-331-32 L			
										
					Innenvierkant G 12,5 DIN 3121 (1/2")		Steckschlüssel		Halter (für Schlüsseleinsatz SW 14)	
DIN 931	DIN 933	DIN 439	DIN 934	SW mm	D mm	L mm	Bestell-Nr.	Bestell-Nr.	Bestell-Nr.	
M 6	M 6	M 6	M 6	10	25	40	804392	—	—	
M 8	M 8	M 8	M 8	13	25	40	804393	804393	—	
M 10	M 10	M 10	M 10	16	30	38	820293	820293	—	
(M 10)	(M 10)	(M 10)	(M 10)	17	30	40	804394	804394	—	
M 12	M 12	M 12	M 12	18	30	38	820294	820294	—	
(M 12)	(M 12)	(M 12)	(M 12)	19	30	40	804395	804395	804245	
M 14	M 14	M 14	M 14	21	30	38	—	820526	—	
(M 14)	(M 14)	(M 14)	(M 14)	22	32,5	40	—	804396	—	
M 16	M 16	M 16	M 16	24	35	45	—	804397	—	
M 18	M 18	M 18	M 18	27	38,5	50	—	804398	—	

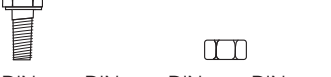
Für MINIMAT[®]-, Demontage-, Rutschkupplungs-, Impuls-, Elektroschrauber

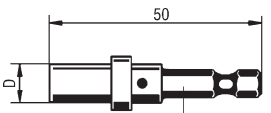
 Sechskantschrauben  Sechskantmutter 					Steckschlüssel mit Außensechskant E 6,3 DIN 3126 (1/4")					
										
					ohne Magnet		mit Magnet		mit Schraubenansaugung	
					Bestell-Nr.		Bestell-Nr.		(nur für MINIMAT [®] gerade Schrauber Gr. 1 u. 2)	
DIN 931	DIN 933	DIN 439	DIN 934	SW mm	D mm	Bestell-Nr.	Bestell-Nr.	D mm	Bestell-Nr.	
M 2,5	M 2,5	M 2,5	M 2,5	5	10	804126	804135	8,5	325363	
M 3	M 3	M 3	M 3	5,5	10	804120	804130	9,5	325153	
(M 3,5)	(M 3,5)	(M 3,5)	(M 3,5)	6	10	804125	804128	9,5	325421	
M 4	M 4	M 4	M 4	7	12	804121	804131	10	324914	
M 5	M 5	M 5	M 5	8	13	804122	804132	11,5	325052	
—	—	—	—	9	14	804113	804152	13	335024	
M 6	M 6	M 6	M 6	10	16	804123	804133	13	325053	
(M 7)	(M 7)	(M 7)	(M 7)	11	15,5	804127	804129	—	—	
—	—	—	—	12	16,5	803791	804111	—	—	
M 8	M 8	M 8	M 8	13	19	804124	804134	—	—	

Für MINIMAT[®]-, Demontage-, Rutschkupplungs-, Elektro-, Schlag-, Impuls-, EC-Servo-Schrauber

Steckschlüssel mit Innenvierkant DIN 3121

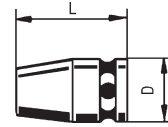

Sechskantschrauben Sechskantmuttern					Kurze Ausführung, ohne und mit Magnet													
					Innenvierkant G 6,3 DIN 3121 (1/4")					Innenvierkant G 10 DIN 3121 (3/8")				Innenvierkant G 12,5 DIN 3121 (1/2")				
DIN 931	DIN 933	DIN 439	DIN 934	SW mm	D mm	L mm	ohne Magnet Bestell-Nr.	mit Magnet Bestell-Nr.	D mm	L mm	ohne Magnet Bestell-Nr.	mit Magnet Bestell-Nr.	D mm	L mm	ohne Magnet Bestell-Nr.	mit Magnet Bestell-Nr.		
M 2,5	M 2,5	M 2,5	M 2,5	5	13	25	804056	804086	—	—	—	—	—	—	—	—		
M 3	M 3	M 3	M 3	5,5	13	23	804057	804087	—	—	—	—	—	—	—	—		
(M 3,5)	(M 3,5)	(M 3,5)	(M 3,5)	6	13	23	804058	804088	—	—	—	—	—	—	—	—		
M 4	M 4	M 4	M 4	7	13	23	804059	804089	19	34	804370	820851	—	—	—	—		
M 5	M 5	M 5	M 5	8	13	23	804060	804090	19	34	804371	820852	25	40	804391	820861		
—	—	—	—	9	13,5	23	804061	804091	19	34	820853	820854	25	40	820862	820863		
M 6	M 6	M 6	M 6	10	15	23	804062	804092	19	34	804372	803768	25	40	804392	820864		
(M 7)	(M 7)	(M 7)	(M 7)	11	16	23	804063	804093	19	34	820855	820856	25	40	803766	820865		
—	—	—	—	12	17,5	23	804064	804094/1	19	34	820295	820857	25	40	820175	820866		
M 8	M 8	M 8	M 8	13	19	23	804065	804095	22	34	804373	820858	25	40	804393	820244		
M 10	M 10	M 10	M 10	16	—	—	—	—	24,5	34	820292	820859	25	40	820293	820867		
(M 10)	(M 10)	(M 10)	(M 10)	17	—	—	—	—	25,5	34	804374	812942	30	40	804394	812923		
M 12	M 12	M 12	M 12	18	—	—	—	—	26,5	34	820311	820860	30	40	820294	820541		
(M 12)	(M 12)	(M 12)	(M 12)	19	—	—	—	—	28	34	804375	820711	30	40	804395	812925		
M 14	M 14	M 14	M 14	21	—	—	—	—	—	—	—	—	32	40	820526	820868		
(M 14)	(M 14)	(M 14)	(M 14)	22	—	—	—	—	—	—	—	—	33	40	804396	820869		
M 16	M 16	M 16	M 16	24	—	—	—	—	—	—	—	—	35,5	45	804397	820870		
M 18	M 18	M 18	M 18	27	—	—	—	—	—	—	—	—	40	50	804398	820871		

Sechskantschrauben Sechskantmuttern					Kurze Ausführung, ohne Magnet														
					Innenvierkant G 16 DIN 3121 (5/8")			Innenvierkant H 20 DIN 3121 (3/4")			Innenvierkant H 25 DIN 3121 (1")			Innenvierkant H 40 DIN 3121 (1 1/2")			Innenvierkant H 63 DIN 3121 (2 1/2")		
DIN 931	DIN 933	DIN 439	DIN 934	SW mm	D mm	L mm	Bestell-Nr.	D mm	L mm	Bestell-Nr.	D mm	L mm	Bestell-Nr.	D mm	L mm	Bestell-Nr.	D mm	L mm	Bestell-Nr.
M 8	M 8	M 8	M 8	13	35	48	803885	—	—	—	—	—	—	—	—	—	—	—	—
M 10	M 10	M 10	M 10	16	35	48	820527	—	—	—	—	—	—	—	—	—	—	—	—
(M 10)	(M 10)	(M 10)	(M 10)	17	35	48	803886	44	50	804410	—	—	—	—	—	—	—	—	—
M 12	M 12	M 12	M 12	18	35	48	820528	44	50	820530	—	—	—	—	—	—	—	—	—
(M 12)	(M 12)	(M 12)	(M 12)	19	35	48	803887	44	50	804411	—	—	—	—	—	—	—	—	—
M 14	M 14	M 14	M 14	21	35	48	820529	44	50	820531	—	—	—	—	—	—	—	—	—
(M 14)	(M 14)	(M 14)	(M 14)	22	35	48	803888	44	50	804412	—	—	—	—	—	—	—	—	—
M 16	M 16	M 16	M 16	24	37	50	803889	44	50	804413	—	—	—	—	—	—	—	—	—
M 18	M 18	M 18	M 18	27	40,5	50	803890	44	50	804414	54	60	804430	—	—	—	—	—	—
M 20	M 20	M 20	M 20	30	—	—	—	46	54	804415	54	63	804431	—	—	—	—	—	—
(M 22)	(M 22)	(M 22)	(M 22)	32	—	—	—	49	53	804416	54	62	804432	—	—	—	—	—	—
M 22	M 22	M 22	M 22	34	—	—	—	51	55	820532	54	62	820533	—	—	—	—	—	—
M 24	M 24	M 24	M 24	36	—	—	—	54	58	804417	57	62	804433	—	—	—	—	—	—
M 27	M 27	M 27	M 27	41	—	—	—	60	58	804418	63	66	804434	—	—	—	—	—	—
M 30	M 30	M 30	M 30	46	—	—	—	66	58	804419	69,5	70	804435	86	84	804450	—	—	—
M 33	M 33	M 33	M 33	50	—	—	—	—	—	—	74,5	70	804436	86	84	804451	—	—	—
M 36	M 36	M 36	M 36	55	—	—	—	—	—	—	81	85	804437	87	90	804452	—	—	—
M 39	M 39	M 39	M 39	60	—	—	—	—	—	—	87,5	85	804438	93	90	804453	—	—	—
M 42	M 42	M 42	M 42	65	—	—	—	—	—	—	—	—	—	99	95	804454	—	—	—
M 45	M 45	M 45	M 45	70	—	—	—	—	—	—	—	—	—	106	100	804455	—	—	—
M 48	M 48	M 48	M 48	75	—	—	—	—	—	—	—	—	—	112	105	804456	—	—	—
M 52	M 52	M 52	M 52	80	—	—	—	—	—	—	—	—	—	118	110	804457	—	—	—
M 56	M 56	M 56	M 56	85	—	—	—	—	—	—	—	—	—	125	110	804458	—	—	—
M 60	M 60	M 60	M 60	90	—	—	—	—	—	—	—	—	—	131	115	804459	—	—	—
M 64	M 64	M 64	M 64	95	—	—	—	—	—	—	—	—	—	137	120	804460	—	—	—
M 68	M 68	M 68	M 68	100	—	—	—	—	—	—	—	—	—	143	125	804461	150	140	804480
M 72	M 72	M 72	M 72	105	—	—	—	—	—	—	—	—	—	150	130	804462	156	147	804481
M 76	M 76	M 76	M 76	110	—	—	—	—	—	—	—	—	—	156	135	804463	162	147	804482
M 80	M 80	M 80	M 80	115	—	—	—	—	—	—	—	—	—	160	128	825633	169	150	804483
M 85	M 85	M 85	M 85	120	—	—	—	—	—	—	—	—	—	—	—	—	175	152	804484
M 90	M 90	M 90	M 90	130	—	—	—	—	—	—	—	—	—	—	—	—	188	160	804485
M 100	M 100	M 100	M 100	145	—	—	—	—	—	—	—	—	—	—	—	—	207	170	804486
M 110	M 110	M 110	M 110	155	—	—	—	—	—	—	—	—	—	—	—	—	218	177	804487

Sicherungsstift und Gummiring extra bestellen

Für MINIMAT[®]-, Demontage-, Rutschkupplungs-, Elektro-, Schlag-, Impuls-, EC-Servo-Schrauber

Steckschlüssel mit Innenvierkant DIN 3121

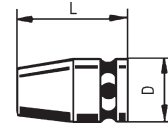

Sechskantschrauben					Lange Ausführung, ohne Magnet								
Sechskantmuttern					Innenvierkant G 6,3 DIN 3121 (1/4")			Innenvierkant G 10 DIN 3121 (3/8")			Innenvierkant G 12,5 DIN 3121 (1/2")		
DIN 931	DIN 933	DIN 439	DIN 934	SW mm	D mm	L mm	Bestell-Nr.	D mm	L mm	Bestell-Nr.	D mm	L mm	Bestell-Nr.
M 4	M 4	M 4	M 4	7	13	45	803767/1	—	—	—	—	—	—
M 5	M 5	M 5	M 5	8	13	45	803759/1	19	51	820872	25	85	804400
—	—	—	—	9	14,5	45	820446/1	19	51	820873	—	—	—
M 6	M 6	M 6	M 6	10	16	45	803760/1	19	51	820874	25	85	804401
(M 7)	(M 7)	(M 7)	(M 7)	11	16	45	820785/1	19	51	820875	—	—	—
—	—	—	—	12	17,5	45	820101/1	19	51	820876	—	—	—
M 8	M 8	M 8	M 8	13	19	45	812931/1	22	51	820877	25	85	804402
M 10	M 10	M 10	M 10	16	—	—	—	24,5	51	820878	30	80	820534
(M 10)	(M 10)	(M 10)	(M 10)	17	—	—	—	25,5	51	820879	30	85	804403
M 12	M 12	M 12	M 12	18	—	—	—	26,5	51	820880	30	80	820535
(M 12)	(M 12)	(M 12)	(M 12)	19	—	—	—	28	51	820881	30	80	804404
M 14	M 14	M 14	M 14	21	—	—	—	—	—	—	30	80	820536
(M 14)	(M 14)	(M 14)	(M 14)	22	—	—	—	—	—	—	32,5	85	804405
M 16	M 16	M 16	M 16	24	—	—	—	—	—	—	35	85	804406
M 18	M 18	M 18	M 18	27	—	—	—	—	—	—	38,5	85	804407

Sechskantschrauben					Lange Ausführung, ohne Magnet											
Sechskantmuttern					Innenvierkant G 16 DIN 3121 (5/8")			Innenvierkant H 20 DIN 3121 (3/4")			Innenvierkant H 25 DIN 3121 (1")			Innenvierkant H 40 DIN 3121 (1 1/2")		
DIN 931	DIN 933	DIN 439	DIN 934	SW mm	D mm	L mm	Bestell-Nr.	D mm	L mm	Bestell-Nr.	D mm	L mm	Bestell-Nr.	D mm	L mm	Bestell-Nr.
(M 10)	(M 10)	(M 10)	(M 10)	17	35	90	803891	44	100	804420	—	—	—	—	—	—
M 12	M 12	M 12	M 12	18	—	—	—	—	—	—	—	—	—	—	—	—
(M 12)	(M 12)	(M 12)	(M 12)	19	35	90	803892	44	100	804421	—	—	—	—	—	—
M 14	M 14	M 14	M 14	21	—	—	—	44	100	820537	—	—	—	—	—	—
(M 14)	(M 14)	(M 14)	(M 14)	22	35	90	803893	44	100	804422	—	—	—	—	—	—
M 16	M 16	M 16	M 16	24	37	90	803894	44	100	804423	54	110	820067	—	—	—
M 18	M 18	M 18	M 18	27	40,5	90	803895	44	100	804424	54	110	804440	—	—	—
M 20	M 20	M 20	M 20	30	—	—	—	46	100	804425	54	110	804441	—	—	—
(M 22)	(M 22)	(M 22)	(M 22)	32	—	—	—	49	100	804426	54	110	804442	—	—	—
M 22	M 22	M 22	M 22	34	—	—	—	51	100	820538	54	108	820539	—	—	—
M 24	M 24	M 24	M 24	36	—	—	—	54	100	804427	57	108	804443	—	—	—
M 27	M 27	M 27	M 27	41	—	—	—	60	100	804428	63	108	804444	—	—	—
M 30	M 30	M 30	M 30	46	—	—	—	67	100	804429	69,5	110	804445	86	130	804465
M 33	M 33	M 33	M 33	50	—	—	—	—	—	—	74,5	115	804446	86	140	804466
M 36	M 36	M 36	M 36	55	—	—	—	—	—	—	81	115	804447	87	140	804467
M 39	M 39	M 39	M 39	60	—	—	—	—	—	—	87,5	115	804448	93	140	804468
M 42	M 42	M 42	M 42	65	—	—	—	—	—	—	—	—	—	99	150	804469
M 45	M 45	M 45	M 45	70	—	—	—	—	—	—	—	—	—	106	150	804470
M 48	M 48	M 48	M 48	75	—	—	—	—	—	—	—	—	—	112	160	804471
M 52	M 52	M 52	M 52	80	—	—	—	—	—	—	—	—	—	118	170	804472
M 56	M 56	M 56	M 56	85	—	—	—	—	—	—	—	—	—	125	170	804473
M 60	M 60	M 60	M 60	90	—	—	—	—	—	—	—	—	—	131	180	804474
M 64	M 64	M 64	M 64	95	—	—	—	—	—	—	—	—	—	137	180	804475
M 68	M 68	M 68	M 68	100	—	—	—	—	—	—	—	—	—	143	190	804476
M 72	M 72	M 72	M 72	105	—	—	—	—	—	—	—	—	—	150	200	804477
M 76	M 76	M 76	M 76	110	—	—	—	—	—	—	—	—	—	156	200	804478

Sicherungsstift und Gummiring extra bestellen

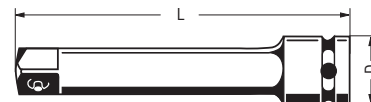

Verlängerungen mit Innenvierkant DIN 3121



Innen-□ Außen-□	G 10 DIN 3121 (3/8") E 10 DIN 3121 (3/8")			G 12,5 DIN 3121 (1/2") E 12,5 DIN 3121 (1/2")			H 20 DIN 3121 (3/4") F 20 DIN 3121 (3/4")			H 25 DIN 3121 (1") F 25 DIN 3121 (1")			H 40 DIN 3121 (1 1/2") F 40 DIN 3121 (1 1/2")		
	D mm	L mm	Bestell-Nr.	D mm	L mm	Bestell-Nr.	D mm	L mm	Bestell-Nr.	D mm	L mm	Bestell-Nr.	D mm	L mm	Bestell-Nr.
—	19	75	804490	25	75	804493	44	175	804497	54	175	804501	86	250	804505
—	19	150	804491	25	125	804494	44	250	804498	54	250	804502	86	380	804506
—	19	300	804492	25	250	804495	44	330	804499	54	330	804503	—	—	—

Sicherungsstift und Gummiring extra bestellen

Für Schlag-, Impuls-, EC-Servo-Schrauber

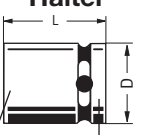
 Innensechskantschrauben  Gewindestifte mit Innensechskant								Klingen/Bits  Außensechskant			Halter 				
DIN 912	DIN 7984	DIN 7991	DIN 913	DIN 914	DIN 915	DIN 916	SW mm	7/16" L = 35 mm Bestell-Nr.	5/8" L = 40 mm Bestell-Nr.	7/8" L = 50 mm Bestell-Nr.	Innen- vierkant DIN 3121	Innen- sechskant	D mm	L mm	Bestell-Nr.
—	—	—	M 6	M 6	M 6	M 6	3	804525	—	—	—	—	—	—	—
—	M 6	M 6	M 8	M 8	M 8	M 8	4	804526	—	—	—	—	—	—	—
M 6	M 8	M 8	M 10	M 10	M 10	M 10	5	804527	—	—	—	—	—	—	—
M 8	—	—	M 12	M 12	M 12	M 12	6	804528	—	—	—	—	—	—	—
—	—	—	M 14	M 14	M 14	M 14	6	804528	—	—	—	—	—	—	—
—	—	—	—	—	—	—	7	820046	—	—	—	—	—	—	—
M 10	M 12	M 12	M 16	M 16	M 16	M 16	8	804529	—	—	—	—	—	—	—
M 12	M 14	M 14	M 18	M 18	M 18	M 18	10	804530	804533	—	G 10 (3/8")	7/16" (11,1 mm)	22	32	804520
—	—	M 16	M 20	M 20	M 20	M 20	10	804530	804533	—	G 12,5 (1/2")	7/16" (11,1 mm)	30	38	804521
M 14	M 16	M 18	M 22	M 22	M 22	M 22	12	804531	804534	—	H 20 (3/4")	5/8" (15,9 mm)	44	52	804522
—	M 18	M 20	M 24	M 24	M 24	M 24	12	804531	804534	—	H 20 (3/4")	7/8" (22 mm)	44	60	804519
M 16	M 20	M 22	—	—	—	—	14	804532	804535	—	H 25 (1")	5/8" (15,9 mm)	54	68	804523/1
M 18	M 22	M 24	—	—	—	—	14	804532	804535	—	H 25 (1")	7/8" (22 mm)	54	70	804524
M 20	M 24	—	—	—	—	—	17	820215	804536	—	—	—	—	—	—
M 22	—	—	—	—	—	—	17	820215	804536	—	—	—	—	—	—
M 24	—	—	—	—	—	—	19	—	—	804537	—	—	—	—	—
M 27	—	—	—	—	—	—	19	—	—	804537	—	—	—	—	—
M 30	—	—	—	—	—	—	22	—	—	804541	—	—	—	—	—
M 33	—	—	—	—	—	—	24	—	—	804542	—	—	—	—	—
M 36	—	—	—	—	—	—	27	—	—	804619	—	—	—	—	—
M 42	—	—	—	—	—	—	32	—	—	804574	—	—	—	—	—
M 48	—	—	—	—	—	—	36	—	—	804618	—	—	—	—	—

Sicherungsstift und Gummiring extra bestellen

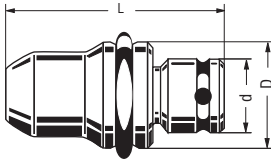
 Stiftschrauben		Stiftschraubenfutter mit Innenvierkant DIN 3121 															
DIN 835	DIN 938	Innenvierkant G 10 DIN 3121 (3/8")				Innenvierkant G 12,5 DIN 3121 (1/2")				Innenvierkant H 20 DIN 3121 (3/4")				Innenvierkant H 25 DIN 3121 (1")			
DIN 938	DIN 939	D mm	d mm	L mm	Bestell-Nr.	D mm	d mm	L mm	Bestell-Nr.	D mm	d mm	L mm	Bestell-Nr.	D mm	d mm	L mm	Bestell-Nr.
—	M 4	35	22	65	790025 A	—	—	—	—	—	—	—	—	—	—	—	—
—	M 5	35	22	65	790025 B	—	—	—	—	—	—	—	—	—	—	—	—
—	M 6	35	22	65	790025 C	—	—	—	—	—	—	—	—	—	—	—	—
—	M 8	35	22	65	790025 D	47	28	79	390203 A	—	—	—	—	—	—	—	—
—	M 10	35	22	65	790025 E	47	28	84	390203 B	—	—	—	—	—	—	—	—
—	M 12	—	—	—	—	47	28	84	390203 C	—	—	—	—	—	—	—	—
—	M 14	—	—	—	—	47	28	84	390203 D	60	41	95	390135/1 A	—	—	—	—
—	M 16	—	—	—	—	47	28	84	390203 E	60	41	95	390135/1 B	—	—	—	—
—	M 18	—	—	—	—	—	—	—	—	60	41	95	390135/1 C	—	—	—	—
—	M 20	—	—	—	—	—	—	—	—	60	41	95	390135/1 D	66	54	131	390168 A
—	M 22	—	—	—	—	—	—	—	—	60	41	95	390135/1 E	66	54	131	390168 B
—	M 24	—	—	—	—	—	—	—	—	60	41	95	390135/1 F	66	54	131	390168 C
—	M 27	—	—	—	—	—	—	—	—	—	—	—	—	66	54	131	390168 D
—	M 30	—	—	—	—	—	—	—	—	—	—	—	—	66	54	131	390168 E
—	M 33	—	—	—	—	—	—	—	—	—	—	—	—	66	54	131	390168 F

Sicherungsstift und Gummiring extra bestellen

Kugelgelenke mit Innenvierkant DIN 3121 																		
Innen-□	G 6,3 DIN 3121 (1/4")			G 10 DIN 3121 (3/8")			G 12,5 DIN 3121 (1/2")			H 20 DIN 3121 (3/4")			H 25 DIN 3121 (1")			H 40 DIN 3121 (1 1/2")		
Außen-□	E 6,3 DIN 3121 (1/4")			E 10 DIN 3121 (3/8")			E 12,5 DIN 3121 (1/2")			F 20 DIN 3121 (3/4")			F 25 DIN 3121 (1")			F 40 DIN 3121 (1 1/2")		
	D mm	d mm	L = 43 mm Bestell-Nr.	D mm	d mm	L = 58 mm Bestell-Nr.	D mm	d mm	L = 78 mm Bestell-Nr.	D mm	d mm	L = 95 mm Bestell-Nr.	D mm	d mm	L = 128 mm Bestell-Nr.	D mm	d mm	L = 178 mm Bestell-Nr.
	16	16	804518	22	22	804510	28	28	804511	38	38	804512	53	53	804513	86	86	804514

Sicherungsstift und Gummiring extra bestellen

Für Schlag-, Impuls-, EC-Servo-Schrauber

Sicherungsstifte und Gummiringe

für Steckschlüssel, Halter, Verlängerungen, Kugelgelenke und Stiftschraubenfutter

Innenvierkant DIN 3121	Steckschlüssel Schlüsselweite mm	Verlängerung Kugelgelenk Halter D mm	Stiftschrauben- futter d mm	Sicherungsstift			Gummiring		
				d mm	l mm	Bestell-Nr.	D mm	d mm	Bestell-Nr.
G 10 (3/8")	7-19	19/22	22	2,5	16	800078	14	3	802513
G 12,5 (1/2")	8-13	25	—	3	20	802348	18	3	803370
G 12,5 (1/2")	16-27	28/30	28	3	24	800012	20	4	802499
G 16 (5/8")	8-27	35	—	3	28	802346	24	4	802524
H 20 (3/4")	17-46	38/44	41	4	32	800056	34	5,5	802546
H 25 (1")	27-60	54	54	5	45	804546	42	7,5	802547
H 40 (1 1/2")	46-90	86	—	5	75	804547	72	6,5	802548
H 40 (1 1/2")	95-110	—	—	6	110	804549	114	10,5	802468
H 63 (2 1/2")	100-155	—	—	8	115	804548	114	10,5	802468

Für Schlagschrauber mit Schnellwechselfutter (Innensechskant DIN 3126 F11,2)

Innensechskant- schrauben		Gewindestifte mit Innensechskant		Klingen						
DIN 912	DIN 7984	DIN 7991	DIN 913	DIN 914	DIN 915	DIN 916	SW mm	Bestell-Nr.		
M 6	M 8	M 8	M 10	M 10	M 10	M 10	5	804515		
M 8	—	M 10	M 12	M 12	M 12	M 12	6	804516		
M 10	M 12	M 12	M 16	M 16	M 16	M 16	8	804538		
M 12	M 14	M 14	M 18	M 18	M 18	M 18	10	804539		
—	—	M 16	M 20	M 20	M 20	M 20	10	804539		
M 14	M 16	M 18	M 22	M 22	M 22	M 22	12	804540		
—	M 18	M 20	M 24	M 24	M 24	M 24	12	804540		
M 16	M 20	M 24	—	—	—	—	14	804517		

Außenvierkant	L mm	Bestell-Nr.	Halter für Steckschlüssel
E 10 DIN 3121 (3/8")	50	804365/1	
E 12,5 DIN 3121 (1/2")	54	804366/1	
F 20 DIN 3121 (3/4")	76	804363/1	

Halter für Klinge/Bit mit Außensechskant C 6,3 DIN 3126 (1/4")		
L mm	D mm	ohne Magnet Bestell-Nr.
65	11,1	825021

DEPRAG

DEPRAG SCHULZ GMBH u. CO.

Postfach 1352, D-92203 Amberg
Kurfürstenring 12-18, D-92224 Amberg
Tel. (096 21) 371-0, Fax (096 21) 371-120
www.deprag.com
info@deprag.de



ZERTIFIZIERT NACH DIN EN ISO 9001